

brand	<b>EUROMAC</b>
-------	----------------

date	MAR/03	SHEET 1/2
------	--------	-----------

Model	Prefix
<b>ES 314 SCHUKO</b>	01

Product number
<b>315001452</b>

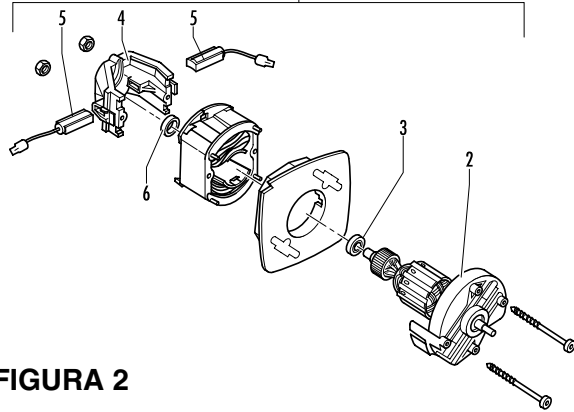

**FIGURA 2**

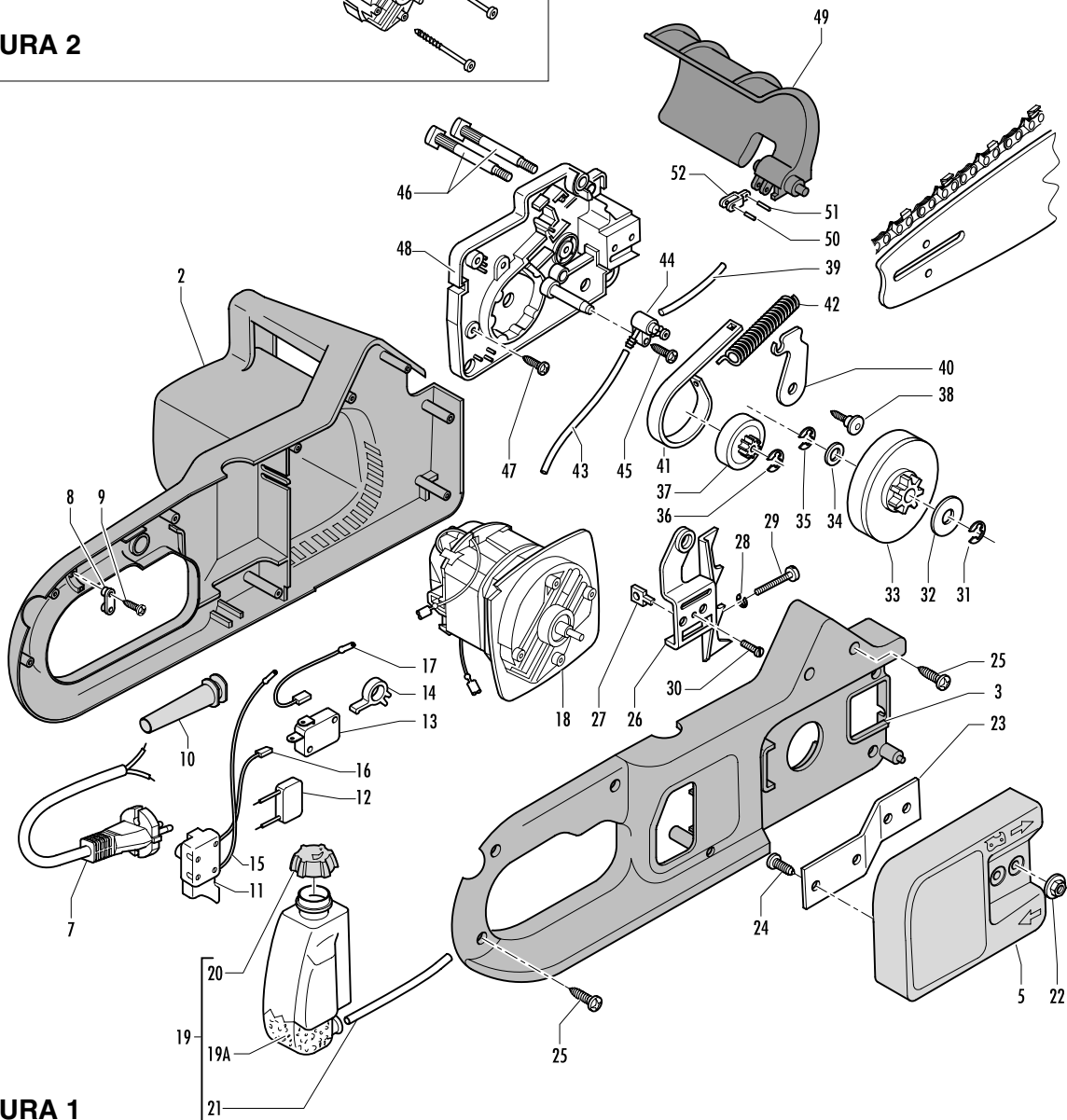

**FIGURA 1**

brand	<b>EUROMAC</b>
-------	----------------

date	MAR/03	SHEET 2/2
------	--------	-----------

Model	Prefix
<b>ES 314 SCHUKO</b>	<b>01</b>

Product number
<b>315001452</b>

**FIGURA 1**

pos	P/N McC	P/N ELX	Qty	DESCRIPTION
2	241847	538241518	1	LEFT CRANKCASE
3	241848	538241519	1	RIGHT CRANKCASE
4	248317	538248317	1	COVER ECS 300
C 5	• 241066	538241066	1	PINION COVER PLATE
C 7	241050	538241050	1	WIRE+PLUG (SCHUKO)
8	241052	538241052	1	CLAMP
9	241077	538241077	2	SCREW M4X14
10	241051	538241051	1	WIRE PROTECTION
C 11	241053	538241053	1	SWITCH
12	240794	538240794	1	NOISE REDUCTION DEVICE
13	229797	538229797	1	MICRO SWITCH
14	241048	538241048	1	SWITCH LEVER
15	241055	538241055	1	MOTOR/SWITCH WIRE
16	241056	538241056	1	SWITCH/ MICROSWITCH WIRE
17	241057	538241057	1	MOTOR SWITCH WIRE
C 18	<b>FIGURA 2</b>			
C 19	4305	538004305	1	OIL TANK ASSY
B 20	• 241060	538241060	1	OIL CAP
C 21	• 242402	538242402	1	OIL TUBE
A 22	235217	538235217	1	M6 NUT
25	240862	538240862	8	SCREW M4X18
26	241036	538241036	1	SPIKE
A 27	241037	538241037	1	CHAIN TENSIONER NUT
B 28	235367	538235367	1	BENZING D.4
B 29	241167	538241167	1	SCREW M5X30
30	229082	538229082	1	SCREW M 2,9X 9,5
B 31	229137	538229137	1	D.8 RING
C 32	241075	538241075	1	10X30X0,8mm WASHER
B 33	241038	538241038	1	ES GEAR ASSY
C 34	241074	538241074	1	10X15X1mm WASHER
35	229137	538229137	1	D.8 RING

pos	P/N McC	P/N ELX	Qty	DESCRIPTION
36	241073	538241073	1	D 8 mm. SEEGER RING
37	241041	538241041	1	PINION
38	241045	538241045	1	SCREW M 4X14
39	229743	538229743	1	OIL TUBE
40	241044	538241044	1	LEVER
41	241500	538241500	1	BRAKE METAL STRIPPING
42	241451	538241451	1	BRAKE SPRING
C 43	229743	538229743	1	FUEL HOSE
B 44	241183	538241183	1	OIL PUMP ASSY
45	240862	538240862	1	SCREW M4X18
A 46	241035	538241035	2	SCREW
47	240862	538240862	5	SCREW M4X18
48	241029	538241029	1	MOTOR HOLDER
C 49	247717	538247717	1	BRAKE LEVER ASSY( BLACK)
50	• 229394	538229394	1	NEEDLE BEARING
51	• 241144	538241144	1	PIN
52	• 241043	538241043	1	TOGGLE
C 53	242365	538242365	1	OIL FILTER

**FIGURA 2**

pos	P/N McC	P/N ELX	Qty	DESCRIPTION
C 1	242401	538242401	1	MOTOR
C 3	• 00216404	538216404	1	BEARING
C 4	• 00248957	538648957	1	BRUSHES HOLDER
C 5	• 00248956	538648956	2	BRUSHES
C 6	• 00216400	538216400	1	BEARING

A= ALTA ROTAZIONE  
B=MEDIA ROTAZIONE  
C=BASSA ROTAZIONE

A=HIGH MOVING  
B=MEDIUM MOVING  
C=SLOW MOVING

A=HAUTE DEMANDE  
B=MOYENNE DEMANDE  
C=BASSE DEMANDE

A=GROBE NACHFRAGE  
B=MITTELMAEBIGE  
C=WENIGE NACHFRAGE